

Lenox Sound[®]

COMPACT DISC PLAYER

AM/FM DUAL CASSETTE RECORDER
WITH REMOTE CONTROL

MODEL CD-162

OPERATING INSTRUCTIONS

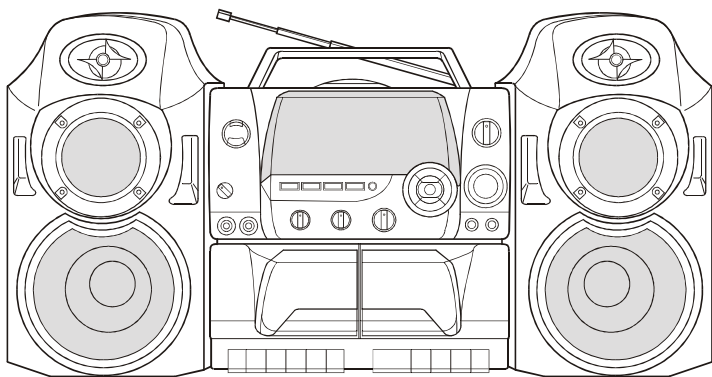

- INCLUDES FULL FEATURE REMOTE CONTROL
- MULTI-COLORED FLUORESCENT DISPLAY
- PLAYS ALL MUSIC COMPACT DISCS
- KARAOKE FUNCTION WITH DUAL MIC. JACKS
- FULLY PROGRAMMABLE CD PLAYER WITH REPEAT PLAY
- RECEIVES AM/FM STEREO BROADCASTS
- ROTARY BASS & TREBLE CONTROLS
- RECORDS FROM CD, TAPE OR RADIO
- 2 WAY POWER - AC/DC
- REQUIRES 8 SIZE "D" BATTERIES (NOT INCLUDED)

PLEASE READ CAREFULLY BEFORE USE

IB-CD162(SLIM)-TA-V1

SAFETY INSTRUCTIONS



The lightning flash and arrow head within the triangle is a warning sign alerting you of "dangerous voltage" inside the product.

CAUTION

**RISK OF ELECTRIC SHOCK
DO NOT OPEN**

CAUTION: TO REDUCE THE RISK OF ELECTRIC SHOCK, DO NOT REMOVE COVER (OR BACK). NO USER SERVICEABLE PARTS INSIDE. REFER SERVICING TO QUALIFIED SERVICE PERSONNEL.



The exclamation point within the triangle is a warning sign alerting you of important instructions accompanying the product.

WARNING: TO REDUCE THE RISK OF FIRE OR ELECTRIC SHOCK, DO NOT EXPOSE THIS APPLIANCE TO RAIN OR MOISTURE.

THESE IMPORTANT SAFETY INSTRUCTIONS ARE INCLUDED, AS APPLICABLE TO THE APPLIANCE, CONVEYING TO THE USER THE INFORMATION ITEMIZED BELOW:

1. **Read Instructions** - All the safety and operating instructions should be read before the appliance is operated.
2. **Retain Instructions** - The safety and operating instructions should be retained for future reference.
3. **Heed Warnings** - All warnings on the appliance and in the operating instructions should be adhered to.
4. **Follow Instructions** - All operating and use instructions should be followed.
5. **Water and Moisture** - The appliance should not be used near water - for example near a bathtub, washbowl, kitchen sink, laundry tub, in a wet basement, or near a swimming pool, and the like.
6. **Wall or Ceiling Mounting** - The appliance should not be mounted to a wall or ceiling.
7. **Ventilation** - The appliance should be situated so that its location or position does not interfere with its proper ventilation. For example, the appliance should not be situated on a bed, sofa, rug, or similar surface that may block the ventilation openings; or, placed in a built-in installation, such as a bookcase or cabinet that impede the flow of air through the ventilation openings.
8. **Heat** - The appliance should be situated away from heat sources such as radiators, heat registers, stoves, or other appliances (including amplifiers) that produce heat.
9. **Power Sources** - The appliance should be connected to a power supply only of the type described in the operating instructions or as marked on the appliance.
10. **Grounding or Polarization** - Precautions should be taken so that the grounding or polarization means of an appliance is not defeated.
11. **Power Cord Protection** - Power supply cords should be routed so that they are not likely to be walked on or pinched by items placed upon or against them, paying particular attention to cords at plugs, convenient receptacles, and the point where they exit from the appliance.
12. **Cleaning** - The appliance should be cleaned only as recommended by the manufacturer.
13. **Nonuse periods** - The power cord of the appliance should be unplugged from the outlet when left unused for a long period of time.

SAFETY INSTRUCTIONS

14. **Object and Liquid Entry** - Care should be taken so that objects do not fall and liquids are not spilled into the enclosure through openings.
15. **Damage Requiring Service** - The appliance should be serviced by qualified service personnel when:
 - A. The power supply cord or the plug has been damaged; or
 - B. Objects have fallen, or liquid has been spilled into the appliance; or
 - C. The appliance has been exposed to rain; or
 - D. The appliance does not appear to operate normally or exhibits a marked change in performance; or
 - E. The appliance has been dropped, or the enclosure damaged.
16. **Servicing** - The user should not attempt to service the appliance beyond that described in the operating instructions. All other servicing should be referred to qualified service personnel.
17. **Power lines** - An outdoor antenna should be located away from power lines.
18. **Outdoor Antenna Grounding** - If an outside antenna is connected to the receiver, be sure the antenna system is grounded so as to provide some protection against voltage surges and built up static charges. Section 810 of the National Electrical Code, ANSI/NFPA 70 provides information with respect to proper grounding of the mast and supporting structure, grounding of the lead-in wire to an antenna discharge unit, size of grounding conductors, location of antenna-discharge unit, connection to grounding electrodes, and requirements for the grounding electrode. See Figure.

EXAMPLE OF ANTENNA GROUNDING AS PER
NEC - NATIONAL ELECTRICAL CODE

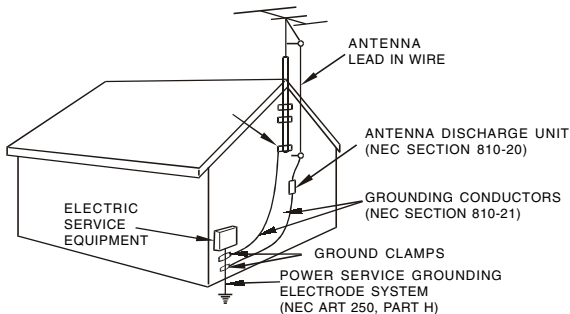

It is the intent of Lennox that this product be used in full compliance with the copyright laws of the United States and that prior permission be obtained from copyright owners whenever copying tapes or CD's.

Do not apply oil or petroleum products or solvents to any part of this set.

CAUTION

Use of controls or adjustments or performance of procedures other than those specified herein may result in hazardous radiation exposure.
This compact disc player is classified as CLASS 1 LASER PRODUCT as stated on the back of the set.

BATTERY SAFETY INSTRUCTIONS

CAUTION: TO REDUCE THE RISK OF FIRE OR PERSONAL INJURY OR DAMAGE TO YOUR SET, READ AND FOLLOW THESE INSTRUCTIONS.

1. Use only the type and size of batteries mentioned in the operating instructions booklet (batteries are not included with this set, please buy the proper batteries).
2. Do not dispose the batteries into a fire. The cells may explode. Check with local codes for possible special disposal instructions.
3. Do not open or mutilate the batteries. Released electrolyte is corrosive and may cause damage to the eyes or skin. It may be toxic if swallowed.
4. Be careful when handling batteries in order not to short the battery with conducting materials such as rings, bracelets and keys. The battery or conductor may over heat and cause burns.
5. Do not attempt to recharge non-rechargeable batteries. The batteries may leak corrosive electrolyte or explode.
6. Do not attempt to rejuvenate the batteries identified for use with this product by heating them. Sudden release of the battery electrolyte may cause burns or irritation to eyes or skin.
7. All batteries should be replaced at the same time. Mixing fresh and discharged batteries could increase internal cell pressure and rupture the batteries.
8. When inserting batteries into this product, the proper polarity (\oplus and \ominus) or direction must be observed. Reverse insertion of some or all of the batteries may result in battery electrolyte leakage or explosion.
9. Remove the batteries from this product if the product will not be used for a long period of time (several months or more) since during the period the batteries could leak, damaging the product.
10. Discard weak or dead batteries as soon as possible since they are more likely to leak in the product. Batteries should be replaced (depending on the product) when the display gets dim or if the Low Battery Indicator shows or if the sound gets distorted.
11. Do not store this product in high temperature areas. Batteries that are stored in a freezer or refrigerator for the purpose of extending shelf life should be protected from condensation during storage and defrosting. Batteries should be stabilized at room temperature prior to use after cold storage.
12. If this product does not operate normally, see TROUBLE SHOOTING in this instruction manual. If you can't resolve the problem, or if the product is damaged, refer to the LENOXX WARRANTY INFORMATION. Opening or removing covers may expose you to dangerous voltages or other risks. Incorrect reassembly can cause electric shock when the appliance is subsequently used.
13. If liquid leaks from the batteries, carefully wipe this liquid. Do not allow it to touch your skin, and discard the leaking batteries.
14. Do not mix batteries (OLD and NEW or CARBON and ALKALINE, etc.).
15. The use of rechargeable batteries is not recommended for this set because their voltage and life is lower than standard batteries.
16. Installation of batteries should be done by an adult only.

SAVE THESE INSTRUCTIONS

CHOOSING THE POWER SOURCES

You can use AC power or batteries as a power source.

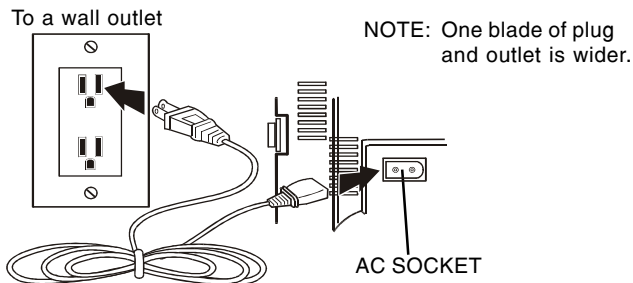

TIP

If the plug of the AC power cord does not match your outlet, do not force it.

Reverse it and try again. The plugs are polarized and only fit one way into the wall outlet and back of the set.

TIP

Replace the batteries when the POWER/BATT. INDICATOR gets dim or when the set stops operating. Replace all the batteries with new ones. Before you replace the batteries, be sure to take out the CD from the player and remember to check the Battery Safety Instructions on Page 3.

1. Connecting the AC power cord

Insert one end of the supplied AC power cord (located in the battery compartment) into the socket located at the back of the set, and the other end to the wall outlet.

2. Using battery power

Insert 8 size "D" batteries (not supplied) into the battery compartment.

To use the player on batteries, disconnect the AC power cord from the player.

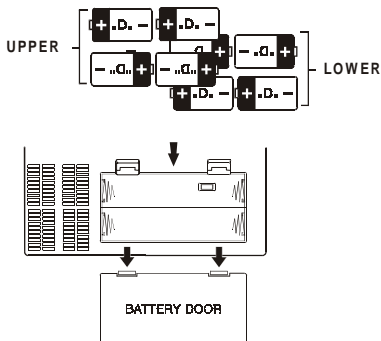

VFD DISPLAY

The VFD display only light up when using AC power.

ATTACHING THE SPEAKERS

1. Bring one of the speaker to the right side of the set.

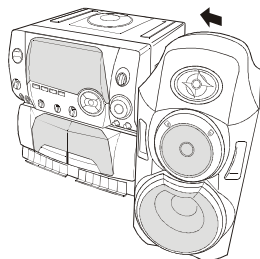

FIG.1

2. Align the rails of the speaker box with the main set as shown in FIG. 1.

3. When speaker align with the rails, push the speaker into the rails as shown in FIG. 2.

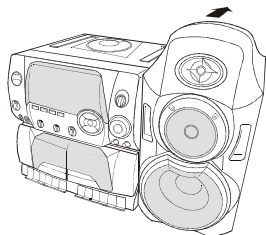

FIG.2

4. Repeat above steps 1 to 3 for the left side.

5. Carefully unwind the speaker wire from behind each speaker box and plug the right plug into Speaker Jack R, also plug the left plug into Speaker Jack L (as shown in FIG. 3). Wrap the remaining wire behind each speaker box.

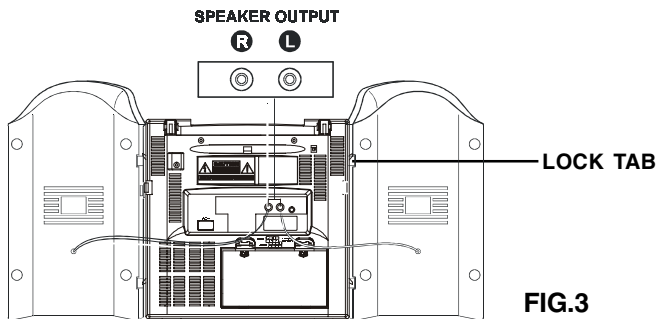

FIG.3

NOTE: This set can be used with speaker boxes attached to the cabinet or separated, just make sure both speaker plugs are plugged into the jacks.

To remove the speakers, press the lock tab and push the speakers out of the rails.

REMOTE CONTROL

You can control the CD PLAYER with the provided REMOTE CONTROL (including the functions of POWER ON/OFF, MUTE, VOLUME control, CD REPEAT and PLAY features).

NOTE: When you use the ROMOTE CONTROL to operate the CD PLAYER, make sure the POWER switch on the main set is turned on, otherwise, the ROMOTE CONTROL will have no functions to the set.

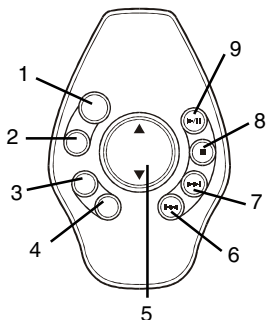

1. POWER ON/OFF
2. MUTE
3. REPEAT - ONE & ALL SONGS
4. PROGRAM
5. VOLUME UP/DOWN
6. SKIP/SEARCH BACKWARD
7. SKIP/SEARCH FORWARD
8. STOP
9. PLAY/PAUSE

NOTE: When you press the POWER ON/OFF switch to shut the set off, the STANDBY indicator on the main set will turn on.

Slide the battery cover to remove. Insert two size "AAA" batteries correctly so that the + and - polarities match the polarity diagrams inside the battery compartment.

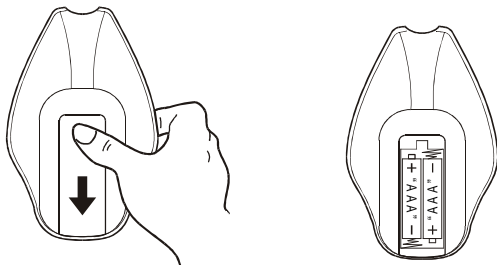







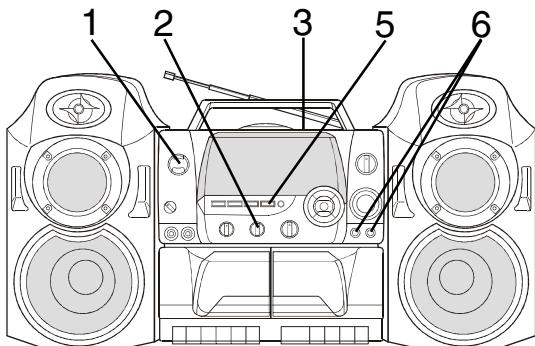

NOTE:

- About half a year of normal operation can be expected when using the alkaline batteries.
- when the batteries are exhausted, the remote control will no longer operate the system. Replace both batteries with new ones.
- When the remote control is not to be used for a long time (2 months or more), remove the batteries to avoid possible damage that may be caused by battery leakage.
- Avoid keeping the remote control in extremely hot or humid locations.
- The remote control's operating distance is about 0.2m (8 inches) to 6m (20 feet) away from the remote sensor.

PLAYING A CD

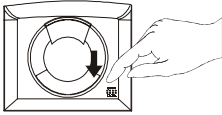
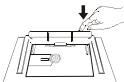

Connect the supplied AC power cord or batteries (see page 4).

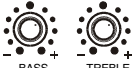
- | | | |
|---|---|---|
| 1

POWER | Press the POWER switch, the POWER/BATT. lamp and the VFD display will turn on. |  |
| 2

RADIO
TAPE CD | Rotate the FUNCTION switch to CD position, two dashes "--" will show on the VFD display. |  |
| 3

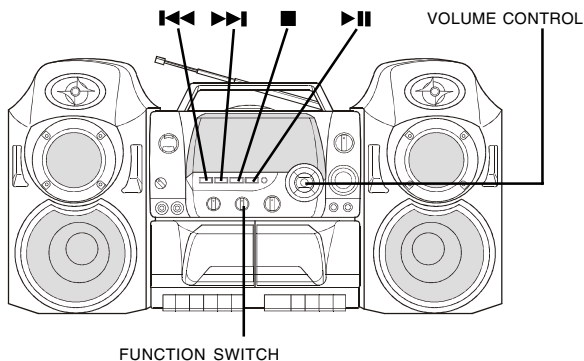
OPEN
CLOSE | Open the CD DOOR by pressing the right corner marked OPEN/CLOSE and place the CD in the CD compartment. The label side of the CD should face upward. |  |
| 4
 | Close the CD DOOR by pushing it down. The display will show the total number of tracks (songs) on that CD . |  |
| 5

PLAY/PAUSE | Press the CD PLAY button. The player will play all the songs (tracks) once in order. |  |
| 6

BASS TREBLE | To change the sound effect, adjust the BASS and TREBLE knobs to your taste. | |

TIP: "--" WILL SHOW IN THE DISPLAY IF THERE IS NO DISC IN THE CD COMPARTMENT OR IF THE DISC IS UPSIDE DOWN.

USE THESE BUTTONS FOR ADDITIONAL OPERATIONS



TIP

When CD play is paused, "▶" will flash and no music will play.



To resume play, press the PAUSE button again, "▶" will stop flashing and music will play.

TIP

If you bump the set or the table it is sitting on, during CD play, the music will stop or skip for a few seconds. This is normal for this type of player.

TIP

This set has an electronic volume control, you may raise or lower the volume by pressing the VOLUME + (UP) and - (DOWN) buttons.

To	Press or Adjust
Adjust the volume	VOLUME control
Stop playback	■ STOP
Pause playback	▶▶ PLAY/PAUSE "▶" will flash during pause. Press again to resume play after pause.
Go to the next track	▶▶ FORWARDS
Go back to the previous track	◀◀ BACKWARDS
Locate a point in a song	◀◀ or ▶▶ Press and hold down while playing until you find the point.
Remove the CD	Press the right corner of the CD DOOR marked OPEN/CLOSE (press STOP first).
Turn off the power	Press the POWER switch, the display and the POWER/BATT. lamp will go off.



REPEAT PLAY

PLAYING CD SONGS (TRACKS) OVER AND OVER

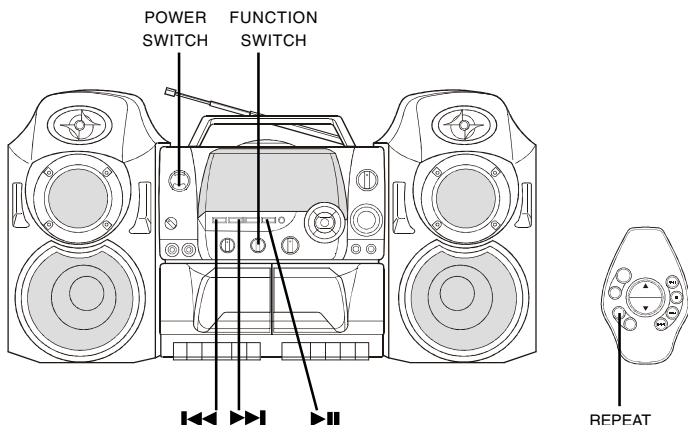
You can play CD tracks over and over in normal or program play modes (see page 10). (NOTE: To use this feature, you need to operate the set with the REMOTE CONTROL, because there is no REPEAT button on the main set.)



1. Press the POWER switch, the POWER/BATT. lamp will turn on and the display will light up.
2. Set the FUNCTION switch to CD position.
3. Select the track by pressing **◀◀** or **▶▶**, and then press **▶||**.
4. Press the CD REPEAT button on the REMOTE CONTROL.

To repeat	Press	Display shows
a single track (song)	Press the REPEAT button once	 "REP" will flash.
all the tracks (all songs)	Press the REPEAT button twice	 "REP" will be steady on
programmed tracks	During programmed play, press the REPEAT button twice	 "REP" is steady on

To cancel Repeat Play

Press the REPEAT button until the "REP" goes off.

PROGRAMMED CD PLAY

SELECTING YOUR OWN MUSIC PLAYING ORDER

You can make a program of up to 19 tracks to play in the order you want them to be played.

NOTE: Programming is only done during stop mode.

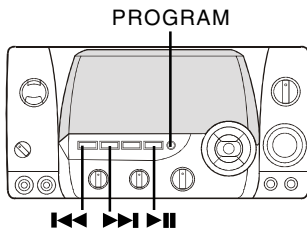



- 1**



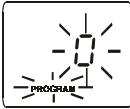

PROG.

During **STOP** mode, press the PROGRAM button. “0” and “PROGRAM” will flash in the display.



- 2**



SKIP/SEARCH

Press the SKIP/SEARCH buttons either  or  until the desired track shows in the display.

- 3**



PROG.

Press the PROGRAM button. “0” and “PROGRAM” will flash in the display.

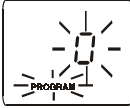

- 4**

Repeat steps 2&3 until all the desired tracks are programmed.
- 5**



PLAY/PAUSE

Press the PLAY button to start programmed play. “▶”, “PROGRAM” and the track number being played will show in the display.



To change the current program

Just create a new program following the programming procedure.

To cancel Program Play

Press the STOP button twice, “PROGRAM” will disappear from the display.

LISTENING TO THE RADIO

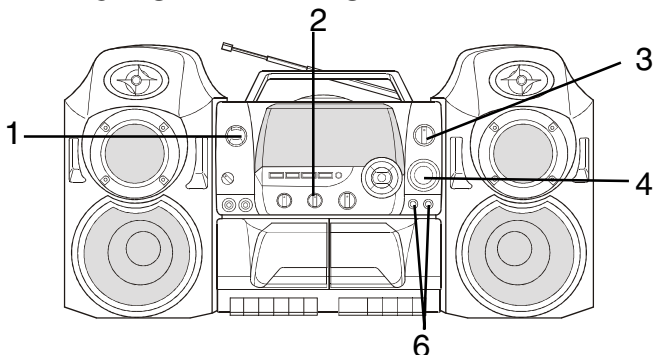

Connect the supplied AC power cord or batteries (see page 4).

- 1**



Press the POWER switch, the POWER/BATT. lamp and the VFD display will turn on.
- 2**



Set the FUNCTION switch to RADIO position.
- 3**

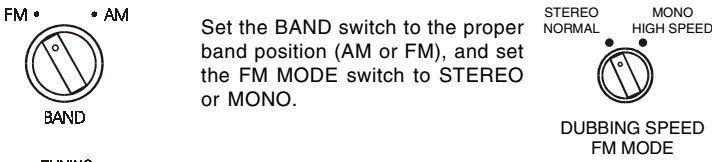

Set the BAND switch to the proper band position (AM or FM), and set the FM MODE switch to STEREO or MONO.
- 4**



Tune into the station you prefer using the TUNING control. Adjust for the clearest sound.
- 5**



This indicator will light up when receiving FM Stereo broadcasts.
- 6**



You may adjust the BASS and TREBLE controls to change the tone of the set to your taste.

USE THESE BUTTONS FOR ADDITIONAL OPERATIONS

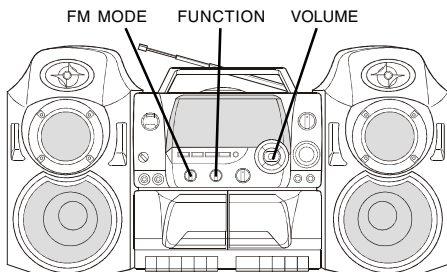

TIP

- If the FM broadcast is noisy, set the FM MODE switch from STEREO to MONO.
- This set has an electronic volume control, you may raise or lower the volume by pressing the VOLUME + (UP) and - (DOWN) buttons.

To

Press or Set

Adjust the volume

VOLUME control (“+” or “-”).

Turn off the Radio

Set the FUNCTION switch to TAPE position or press the POWER switch.

To improve broadcast reception

Change position of the antenna for FM or FM Stereo.
Move the set itself for AM.

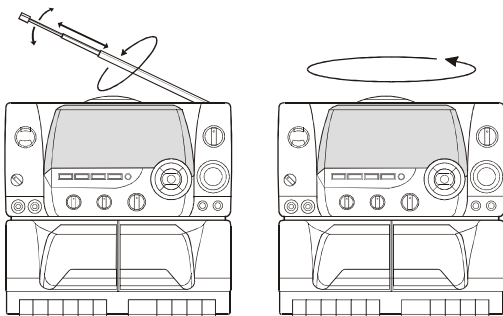

PLAYING A TAPE

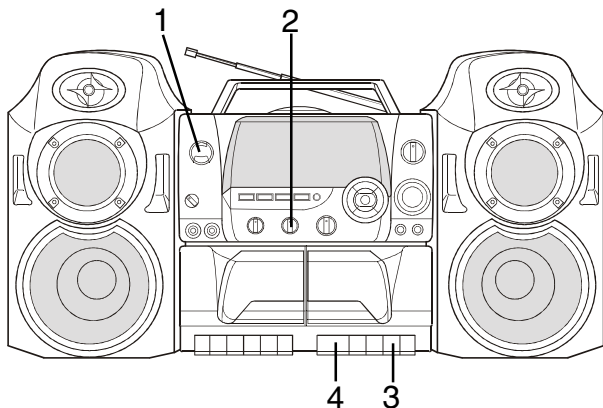

Connect the supplied AC power cord or batteries (see page 4).

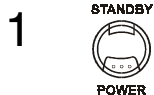

Press the POWER switch, the POWER/BATT. lamp and the VFD display will turn on.



Set the FUNCTION switch to TAPE position.



Press the STOP/EJECT button (DECK A or DECK B) to open the tape compartment and insert a recorded tape. Close the door.



Press the PLAY button. The player turns on and starts playing.



When the set finishes playing one side of the tape, the set will stop. To hear the other side of the tape, flip the tape over, then insert and press PLAY.

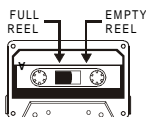

INSERT THIS WAY

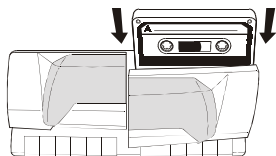
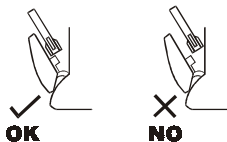

RELAY PLAY

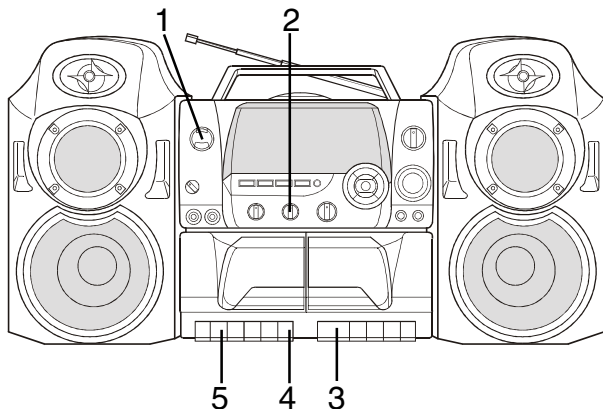

Connect the supplied AC power cord or batteries (see page 4).

To play tapes in DECK A and then DECK B, follow the steps below:

- 1**



Press the POWER switch, the POWER/BATT. lamp and the VFD display will turn on.
- 2**



Set the FUNCTION switch to TAPE position.
- 3**



Press the cassette PLAY button on DECK A, DECK A will play.
- 4**



Press the cassette PAUSE button on DECK B.
- 5**



Press the cassette PLAY button on DECK B. When DECK A finishes playing, DECK B will start playing automatically.
- 6**

When the tape finishes playing on DECK B, the set will stop.

USE THESE BUTTONS FOR ADDITIONAL CASSETTE TAPE OPERATIONS

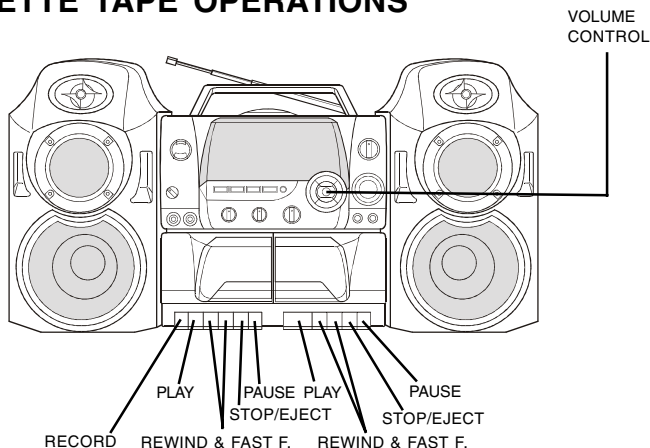

To	Press or Adjust
Adjust the volume	Press the VOLUME button ("+" or "-")
Stop playback	STOP/EJECT button
Fast forward or rewind the tape	FAST FORWARD button or REWIND button
Pause playback	PAUSE button Press again to resume play after pause.
Eject the cassette	STOP/EJECT button
To enjoy the music without disturbing others (headphones are not included)	Insert your headphone plug into the HEADPHONE jack (at the back of the set).
To shut power off	Make sure cassette buttons are all up (stop) and POWER switch is off.

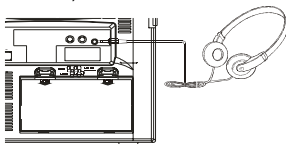

RECORDING ON A TAPE

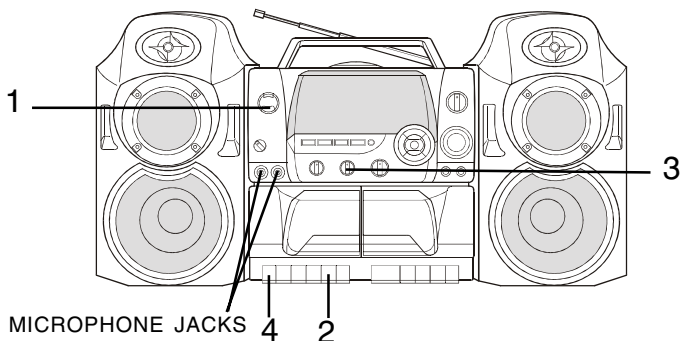

MICROPHONE JACKS 4 2

Connect the supplied AC power cord or batteries (see page 4).

1  **POWER** Press the **POWER** switch, the **POWER/BATT.** lamp and the **VFD** display will turn on.



2  **STOP/EJECT** Press the **STOP/EJECT** button (**DECK B**) to open the tape compartment and insert a blank tape. Select the program source (**AM**, **FM**, **CD**, or microphone) you want to record.

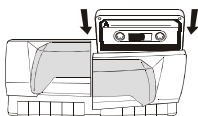



3  To record from the **CD** player, set the **FUNCTION** switch to **CD** position, insert a **CD** and follow the steps to play a **CD** (see page 7).



To record from a radio, set the **FUNCTION** switch to **RADIO** position, and tune into the station you want (see page 11).

To record from the microphone, set the **FUNCTION** switch to the **TAPE** position, and plug the microphone(s) (not included) into either of the **MIC JACKS**. Speak into the microphone.

To record from the **DECK A**, set the **FUNCTION** switch to the **TAPE** position, and follow the steps to play a **TAPE** (see page 13).

OR  **OR**  **THEN**  **RECORD**

Press the **RECORD** button to start recording. (The **PLAY** button is depressed automatically.)

5  **REWIND**  **PLAY** To hear what you recorded, set the **FUNCTION** switch to **TAPE** position, then press **REWIND** and **PLAY**.

USE THESE BUTTONS FOR ADDITIONAL OPERATIONS

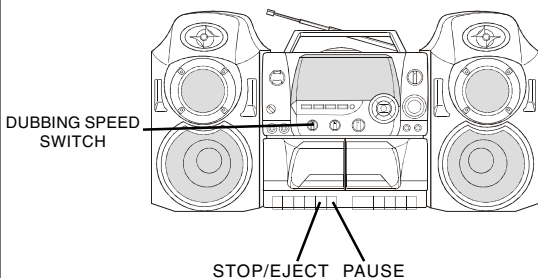

TIP

- For best recording effect, use the AC power instead of batteries.
- To erase a recording, just start a new recording, and the old one is automatically replaced.
- see page 21 for notes on cassettes.

To	Press or Set
Stop recording	STOP/EJECT button
Pause recording	PAUSE button Press the button again to resume recording.
Adjust recording speed when copying tapes	DUBBING SPEED switch from NORMAL to HIGH speed.
Turn off the power	Press the STOP/EJECT button and press the POWER switch, the POWER/BATT. lamp will go off.

SINGING ALONG WITH KARAOKE FUNCTION

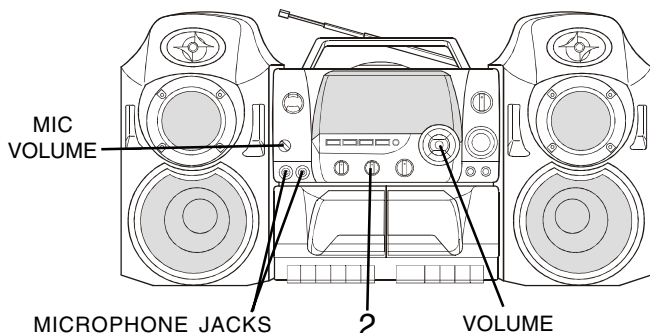

Connect the supplied AC power cord or batteries (see page 4).



Insert microphone plugs into the microphone jacks. To avoid mic howling, lower the volume level setting first.

NOTE: Microphones are not included, you may purchase microphones where you bought this set.

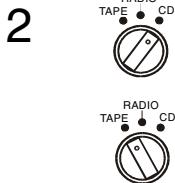

To sing along with the CD player, set the FUNCTION switch to CD position, insert a KARAOKE CD disc and follow the steps to play a CD (see page 7).

To sing along with the tape, set the FUNCTION switch to the TAPE position, insert a KARAOKE TAPE into deck A or B, and follow the steps to play a TAPE (see page 13).

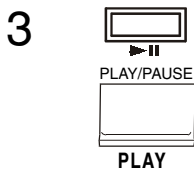





Press the CD PLAY/PAUSE button on the CD player or press the PLAY button on deck A or B.

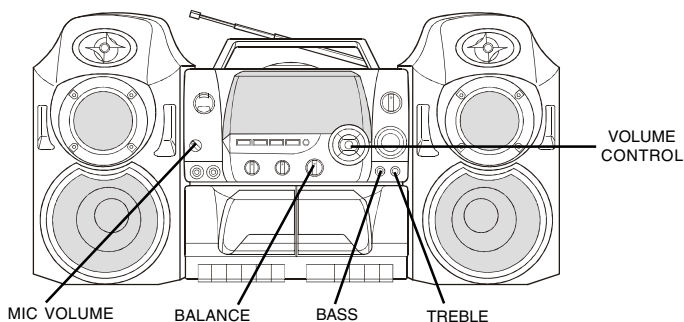

Adjust the volume controls (both the set's VOLUME control and the MICROPHONE VOLUME control) to achieve the best effect.

USE THESE BUTTONS FOR ADDITIONAL OPERATIONS



	To	Press or Adjust
 MIC VOLUME	Adjust the MIC volume	MIC VOLUME
 VOLUME	Adjust the CD or TAPE music volume	VOLUME control
 BALANCE	Adjust the RIGHT & LEFT channel output.	BALANCE control
 BASS TREBLE	Adjust the sound effects for low high tones.	BASS or TREBLE controls.

TIP: If there is squealing or howling (feedback) noise during KARAOKE use, move the microphone away from the speakers or turn down the volume. Set the KARAOKE switch to OFF position for better music play.

PRECAUTIONS

On Safety

- As the laser beam used in the CD player section may be harmful to the eyes, do not attempt to disassemble the cabinet. Refer servicing to qualified personnel only.
- Should any solid object or liquid fall into the set, unplug the player, and have it checked by qualified personnel before operating it any further.

On Placement

- Do not leave the set in a location near a heat source, or in a place subject to direct sunlight, excessive dust or mechanical shock.
- Do not place the set on an inclined or unstable place.
- Do not place anything within 1 inch of the back of the cabinet. The ventilation holes must not be covered for the set to operate properly and prolong the life of its components.
- If the set is left in a car parked in the sun, be sure to choose a location in the car where the set will not be subjected to the direct rays of the sun.
- Since a strong magnet is used for the speakers, keep personal credit cards using magnetic coding or springwound watches away from the speakers to prevent possible damage from the magnets.

On Power Sources

- For battery operation, use 8 size D batteries. We recommend alkaline batteries for longer life.
- If the batteries will not be used for a few weeks or more, remove them to avoid damage that can be caused by battery leakage.

On Operation

- If the set is brought directly from a cold to a warm location, or is placed in a very damp room, moisture may condense on the lens inside the CD player section. Should this occur, the set will not operate properly. In this case, remove the CD and wait about an hour for the moisture to evaporate. If the set has not been used for a long time, set it in the playback mode to warm it up for a few minutes before inserting a cassette.
- This set is designed to be played on a stable no vibration position. If you bump the set during CD play, the music will stop or skip for a few seconds. This is normal for this type of player.
- If you have any questions or problems concerning your player, please contact our customer service department at 1-800-315-5885.
(Monday - Thursday 09:00 AM - 05:00 PM,
Friday 09:00 AM - 01:00 PM EST)

PRECAUTIONS (continued)

Notes on CDs

- Before playing, clean the CD with a cleaning cloth. Wipe the CD from the center out.



- Do not use solvents such as benzene, thinner, commercially available cleaners or anti-static spray intended for vinyl LPs.
- Do not expose the CD to direct sunlight or heat sources such as hot air ducts, nor leave it in a car parked in direct sunlight as there can be a considerable rise in temperature inside the car and result in a damaged CD.
- Do not stick paper or stickers on the CD, nor scratch the CD.
- After playing, store the CD in its case. If there is a scratch, dirt or fingerprints on the CD, it may cause a tracking error or skipping.

Notes on Cassettes

- Break off the cassette recording tabs from side A or B to prevent accidental recording.

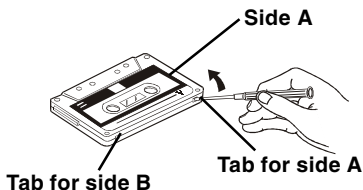

- To record on a tape with its tab broken off, cover the respective tab hole for side A or B with adhesive tape.
- The use of a cassette with more than 90 minutes of play time is not recommended except for long continuous recording or playback.
- To reduce the chances of tape jamming or tangling, you should check that there are no loose layers of tape visible through the cassette center window. If any, tighten these loose layers of tape using a pencil before inserting the cassette into the set.

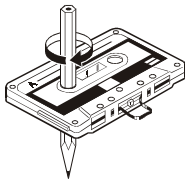

MAINTENANCE

Cleaning the Lens

If the lens becomes dirty, it may cause a skipping of sound during CD operation. Clean with a commercially available lens cleaner and blower.

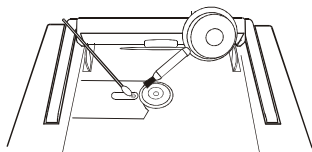

Notes for Storing Cassette Tapes

1. Do not put a tape near a magnetic field, such as a TV, or speaker. Magnetic fields may reduce the tape sensitivity or even erase the recording.
2. Do not store tape for any length of time in a hot, moist or dusty place.

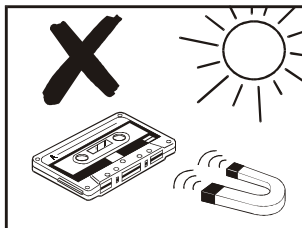

Cleaning the Tape Heads

Wipe the heads, the pinch roller and the capstan with a cleaning swab slightly moistened with cleaning fluid or alcohol after every 10 hours of operation for optimum playback and recording quality. After cleaning, insert a tape when the areas cleaned are completely dry.

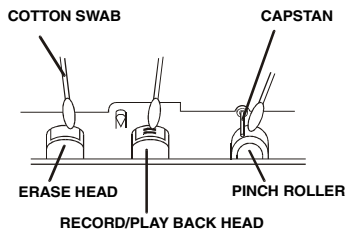

Cleaning the Cabinet

Clean the cabinet, panel and controls with a soft cloth slightly moistened with water or a mild detergent solution. Do not use any type of abrasive pad, scouring powder, or solvent, such as alcohol or benzene.

NOTE: In order to see and clean the head, you may have to press PLAY first.

TROUBLE SHOOTING

	Problem	Remedy
General	The power is not on.	<ul style="list-style-type: none">• Connect the AC power cord to a wall outlet securely.• Make sure the batteries are inserted correctly and they are fresh.
	There is no sound.	<ul style="list-style-type: none">• Make sure the FUNCTION switch is at the right position as you want.• Adjust the volume.• Unplug the headphones when listening through speakers.
	VFD display does not light up.	<ul style="list-style-type: none">• You may use battery power, the VFD display only light up when using AC power.
CD player	“ - - ” appears in the display even when a CD is in place.	<ul style="list-style-type: none">• Insert the CD with the label side up.
	CD does not play.	<ul style="list-style-type: none">• Make sure that the CD compartment is closed.• Place the CD with the label side up.• Clean the CD.• Take out the CD and leave the CD DOOR open for about an hour to dry moisture condensation.• Make sure the FUNCTION switch is at CD position.
	The sound drops out.	<ul style="list-style-type: none">• Clean the CD, or replace it if the CD is badly damaged.• Place the player in a location free from vibration.• Check if your batteries are fresh.
Radio	The sound is weak, or has poor quality.	<ul style="list-style-type: none">• Replace all the batteries with new ones if they are weak, or bring the set near a window, or rotate the set.
Tape player	The RECORD button does not function/The tape does not play.	<ul style="list-style-type: none">• Make sure the safety tab on the cassette is in place (see page 21).• Make sure the FUNCTION switch is at TAPE position.
	The tape does not erase completely.	<ul style="list-style-type: none">• Clean the erasing head (see page 22).• Replace all the batteries with new ones if they are weak.
	The tape does not record.	<ul style="list-style-type: none">• Make sure the tape is inserted properly.• Make sure the safety tab of the cassette is in place.
	The sound is weak/The sound quality is poor.	<ul style="list-style-type: none">• Clean the heads, pinch roller and capstan (see page 22).
	Cassette PLAY button pops up.	<ul style="list-style-type: none">• The tape has reached its end. Remove it, flip to the other side and re-insert.

SPECIFICATION

General Description

Power source:	AC 120V, 60Hz 22Watts DC 8 size "D" batteries for set DC 2 size "AAA" batteries for Remote Control (Alkaline batteries are recommended)
Speakers (2 ways): and	2 - 5" 4 ohm woofers 2 - 3" 4 ohm tweeters with crossover
Output power:	5.0W/channel
Dimensions:	Width: 24 1/4" Depth: 8 1/2" Height: 12 7/8" Weight: 15.4LBs

CD Section

Plays disc type:	Any normal CD used in portable players	
Laser wavelength:	760 - 800 NM	
Tracking method:	3 - spot error detection	3.86 mm lens
Frequency response:	50Hz - 15kHz +1/-2 dB	

Tape Recorder Section

Frequency response:	Standard normal bias cassette tape, 70Hz - 10kHz
---------------------	---

Radio Section

Frequency range:	FM: 88 - 108 MHz AM: 530 - 1700 kHz
------------------	--

LENOXX reserves the right to make design and specification changes for product improvement.

PROTECT YOUR FINE FURNITURE!

WE RECOMMEND A CLOTH OR OTHER PROTECTIVE MATERIAL BE PLACED UNDER THE SET WHEN PLACING IT ON SURFACE WITH A NATURAL OR LACQUER FINISH.

LIMITED WARRANTY

We warrant this product to be free from defects in material and workmanship under normal use for a period of 90 days after purchase and we will repair it free of charge or replace it at no charge, should it become defective under this warranty, providing you submit proof of purchase (sales slip) with the set.

During the initial 90 day period after original purchase, we will service or exchange, at no charge, the set that is returned to LENOXX ELECTRONICS CORP. After the initial 90 day period expires, and for a period of 12 months from original purchase, we will repair the unit covering any part(s) that need to be replaced at no charge, but will charge for the cost of labor, return postage paid by Lenoxx.

This warranty does not apply to any products which have been subject to misuse, neglect or accident. This warranty does not cover broken cabinet. UNDER NO CIRCUMSTANCES WILL LENOXX ELECTRONICS CORP. BE LIABLE FOR ANY INCIDENTAL OR CONSEQUENTIAL DAMAGES. Some states do not allow the exclusion or limitation of incidental or consequential damages, so the above limitations or exclusions may not apply to you.

This warranty gives you specific legal rights, and you may also have other rights which vary from state to state. The following charges apply to repairs beyond the warranty period: \$45.00. Be sure to pack carefully and return postage paid insured together with your money order (personal checks will not be accepted) and sales receipt to :

LENOXX ELECTRONICS CORP. 2 GERMAK DRIVE, CARTERET N.J. 07008

For customer service

Dial 1-800-315-5885 (MONDAY - THURSDAY 9:00 AM - 5:00 PM, FRIDAY 9:00 AM - 1:00 PM EST)

or Visit Our Website: <http://www.lenoxx.com>

© 2001 LENOXX ELECTRONICS CORP.
2 GERMAK DRIVE
CARTERET, N.J. 07008
MADE & PRINTED IN CHINA